

Article datasheet

Hole Grommet 3.0/5.0-2.0mm TPE black

Article-No.: 014.80.160

Manufacturer: SES-Sterling

Manufacturer article-no.: 0145 0006 010

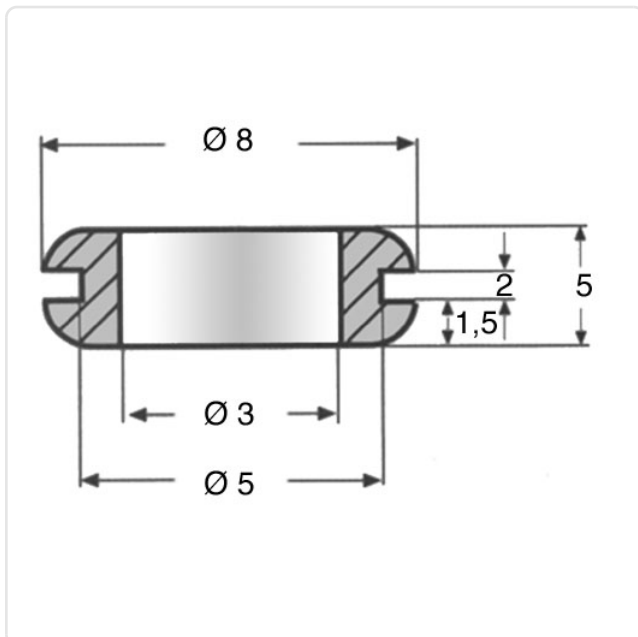

Image may be similar

Color:	Black
Inner Diameter [mm]:	3
Material:	TPR - Thermoplastic Elastomer
Material Group:	Plastic
Max. Panel Thickness [mm]:	2
Mounting Hole [mm]:	5
Weight:	0.17g
Conformities:	



You can find all information on the web on our article detail page



Would you like individual advice?

We look forward to your email to products@ettinger.de.

Subject to change and errors.