

Article datasheet

Pan Head Screw ISO7045 M3x10 A4 STEEL C/R Self-Sealing SEELSKREW®

Article-No.: 001.57.349

Manufacturer: APM Hexseal

Manufacturer article-no.: RM3X10 SEELSKREW

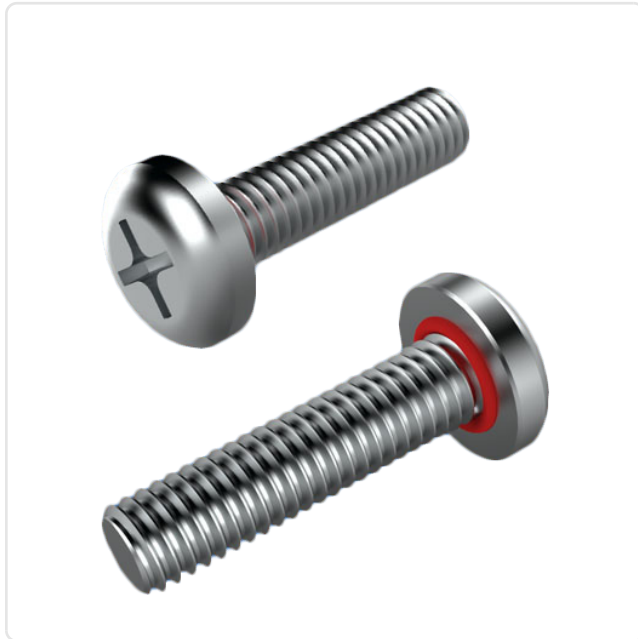
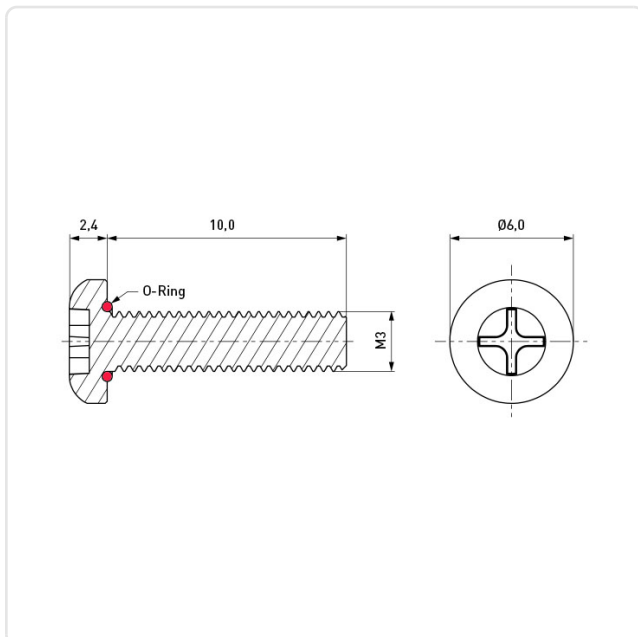

Image may be similar

Actuator Size:	Phillips PH1
DIN/ISO:	DIN7985 / ISO7045
Drive Type:	Cross Recess / Phillips-H
Finish:	Passivated, Clear
Head Diameter [mm]:	6
Head Height [mm]:	2.4
Head Shape:	Flat Head
Length [mm]:	10
Material:	Stainless Steel AISI 316 / A4
Material Group:	Stainless Steel
O-Ring Material:	Silicone
Temperature Range [°C]:	-106°C to +260°C
Thread Size:	M3
Weight:	0.8g
Conformities:	



You can find all
information on the web on
our article detail page

Would you like individual advice?

We look forward to your email to products@ettinger.de.

Subject to change and errors.