

Article datasheet

Screw for T-Slot DIN787 M12x65/40 Plain Steel 8.8

Article-No.: 001.42.122

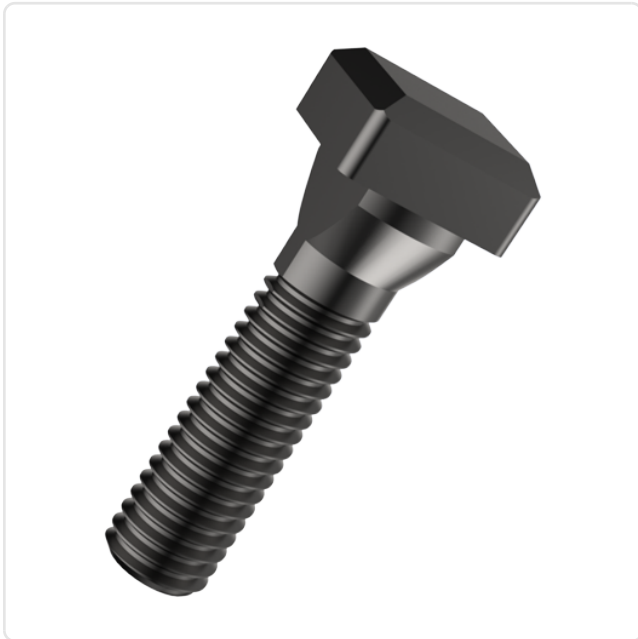
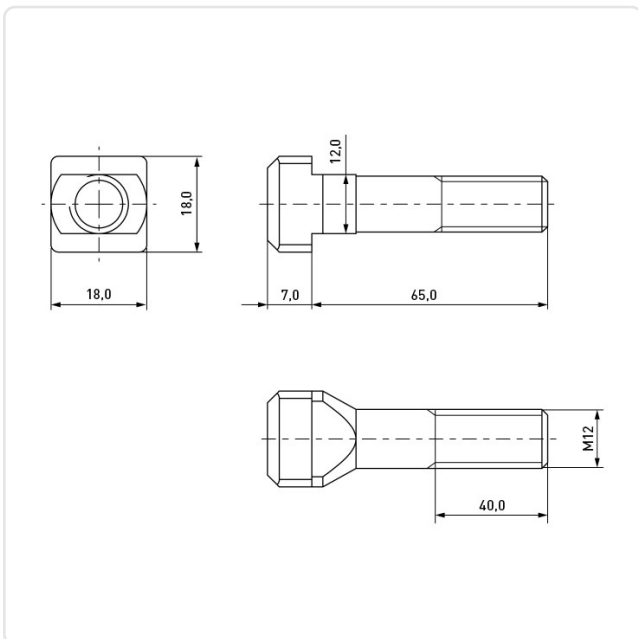

Image may be similar

DIN/ISO: DIN787
Finish: Plain
Head Height [mm]: 7
Head Shape: Hammer Head
Length [mm]: 65
Material: Steel 8.8
Slot Width [mm]: 12
Thread Length [mm]: 40
Thread Size: M12
Conformities:



You can find all
information on the web on
our article detail page



Would you like individual advice?

We look forward to your email to products@ettinger.de.

Subject to change and errors.