

Article datasheet

PCB Support 6.4 | \varnothing 4.3 Polyamide 6.6 natural

Article-No.: 006.25.306

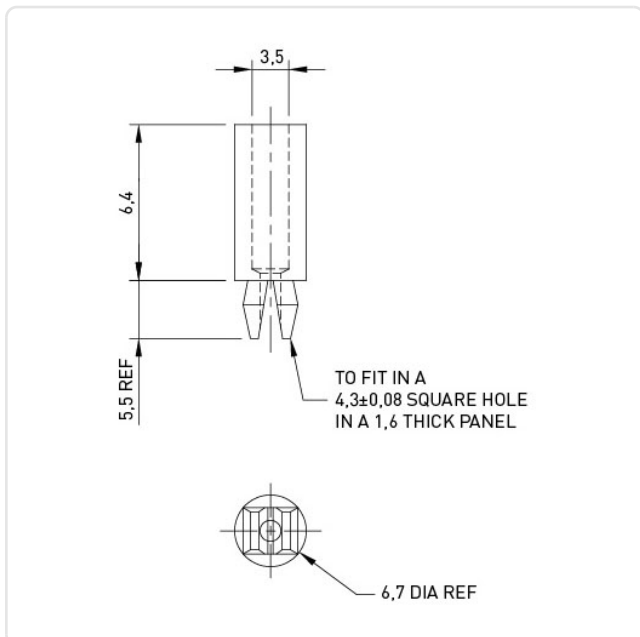

Image may be similar

Color: Natural
Flammability Class: UL94-V2
Length [mm]: 6.4
Material: PA 6.6
Material Group: Plastic
Panel Hole \varnothing [mm]: 4.3
Panel Thickness [mm]: 1.6
Weight: 0.29g
Conformities:



You can find all information on the web on our article detail page



Would you like individual advice?

We look forward to your email to products@ettinger.de.

Subject to change and errors.