

Article datasheet

## Harness Rap 10 -40, PE, natural, 25m roll

Article-No.: 014.75.331

Manufacturer: SES-Sterling

Manufacturer article-no.: 0819 0009 001



Image may be similar

Bundle Diameter [mm]: 10,0-40,0

Color: Natural

Flammability Class: UL94-V2

Material: PE - Polyethylene

Model: Spiral Cable Wrap

Reel length [m]: 25

Weight: 1011g

Conformities:



You can find all  
information on the web on  
our article detail page

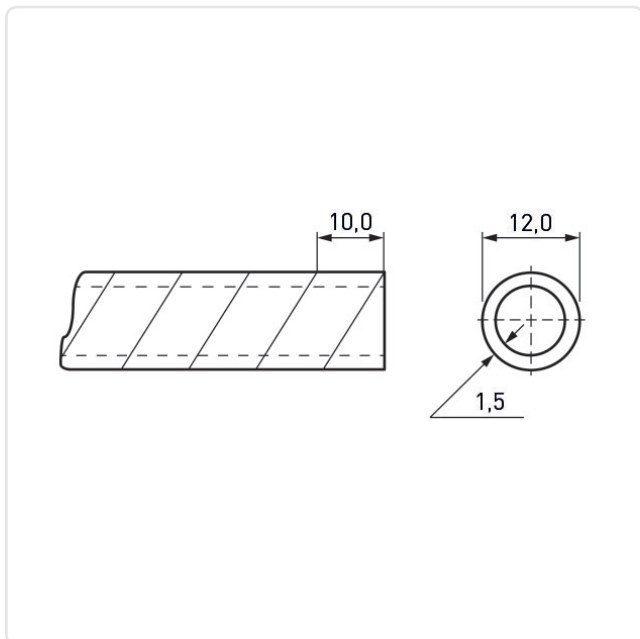

Would you like individual advice?

We look forward to your email to [products@ettinger.de](mailto:products@ettinger.de).

Subject to change and errors.