

Article datasheet

Combination Nut M8 Galvanized Steel Rotatable Washer

Article-No.: 002.09.118

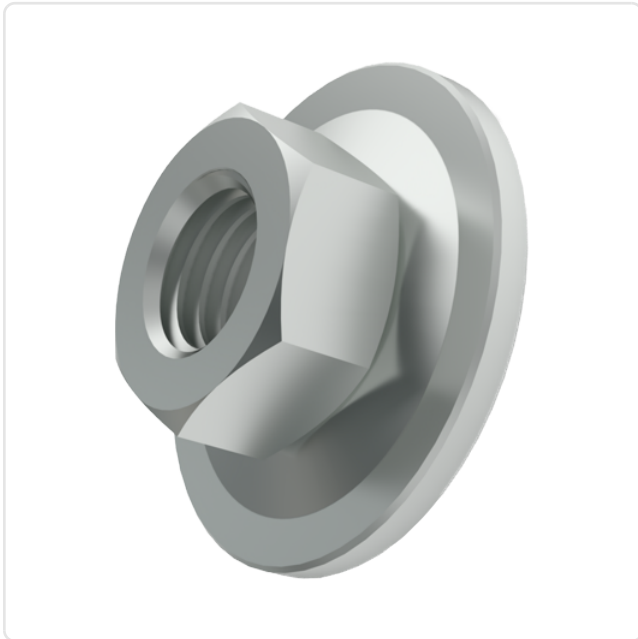

Image may be similar

AF / OD [mm]: 13
Finish: Galvanized, Blue, 5 µm, A2K
Height [mm]: 9.7
Material: Steel
Material Group: Stahl
Thread Size: M8
Weight: 10.4g
Conformities:



You can find all
information on the web on
our article detail page

Would you like individual advice?

We look forward to your email to products@ettinger.de.

Subject to change and errors.

