

Article datasheet

Flat Washer DIN433/ISO7092 Ø3.2/6.0 x 0.5 Nickel-Plated Steel

Article-No.: 003.01.033



Image may be similar

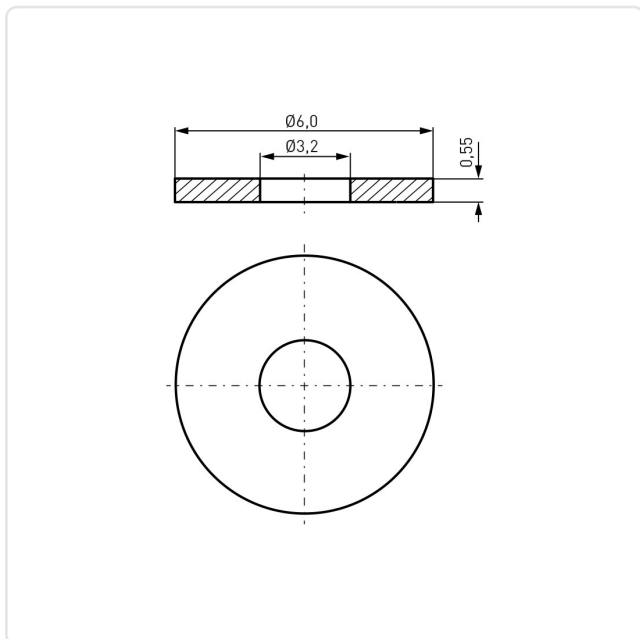

DIN/ISO: DIN433 / ISO7092
Finish: Nickel-Plated, 3 µm, E1E
For Thread Size: M3
Height [mm]: 0.5
Inner Diameter [mm]: 3.2
Material: Steel
Material Group: Stahl
Outer Diameter [mm]: 6
Weight: 0.07g
Conformities:



You can find all
information on the web on
our article detail page

Would you like individual advice?

We look forward to your email to products@ettinger.de.

Subject to change and errors.