

Article datasheet

Hole Grommet 5.0/8.0-1.5mm TPE black

Article-No.: 014.80.343

Manufacturer: SES-Sterling

Manufacturer article-no.: 0145 0011 010

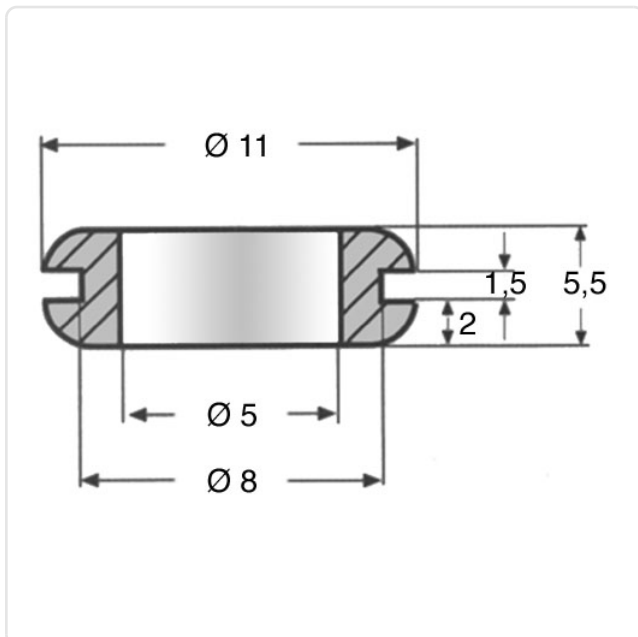

Image may be similar

Color:	Black
Inner Diameter [mm]:	5
Material:	TPR - Thermoplastic Elastomer
Material Group:	Plastic
Max. Panel Thickness [mm]:	1.5
Mounting Hole [mm]:	8
Weight:	0.35g
Conformities:	



You can find all
information on the web on
our article detail page



Would you like individual advice?

We look forward to your email to products@ettinger.de.

Subject to change and errors.