

Article datasheet

Long Nut M14 DIN6334 Galvanized Steel AF 22x42 / M14

Article-No.: 002.20.141

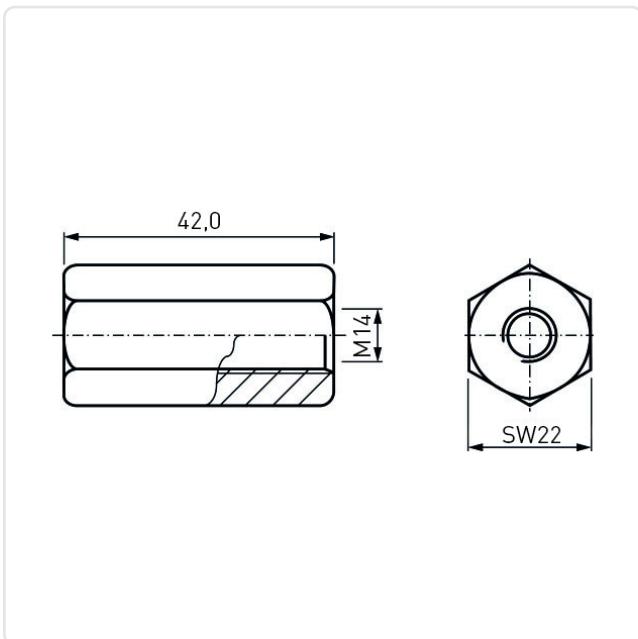

Image may be similar

DIN/ISO: DIN6334
Finish: Galvanized, Blue, 5 µm, A2K
Length [mm]: 42
Material: Steel AISI 12L13 / 11SMnPb30
Material Group: Steel
Profile: Hexagonal
Thread Size: M14
Conformities:



You can find all
information on the web on
our article detail page



Would you like individual advice?

We look forward to your email to products@ettinger.de.

Subject to change and errors.