

Article datasheet

PCB Support 9.5 Self-Adhesive Polyamide 6.6 natural

Article-No.: 006.21.809

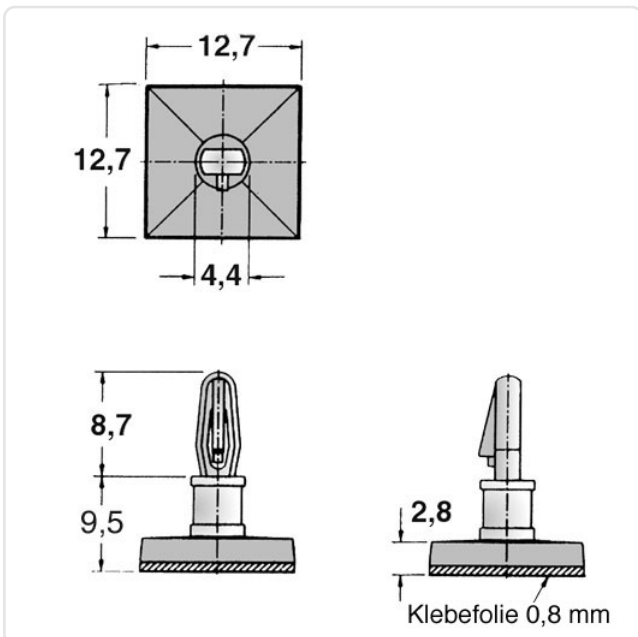

Image may be similar

Color: Natural
Flammability Class: UL94-V2
Length [mm]: 9.5
Material: PA 6.6
PCB Hole Ø [mm]: 3.2
PCB Thickness [mm]: 1,6
Weight: 0.56g
Conformities:



You can find all information on the web on our article detail page



Would you like individual advice?

We look forward to your email to products@ettinger.de.

Subject to change and errors.