

Article datasheet

## Locking and Sealing Washer $\text{\O}6.2/10.0 \times 3.5$ Polyamide 6 natural

Article-No.: 003.07.466

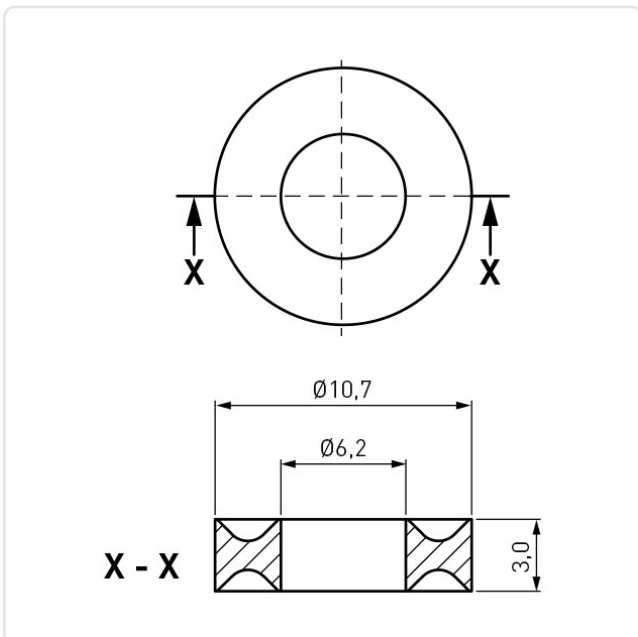

Image may be similar

For Thread Size: M6  
Height [mm]: 3.5  
Inner Diameter [mm]: 6.2  
Material: PA 6.0  
Material Group: Plastic  
Outer Diameter [mm]: 10  
Weight: 0.15g  
Conformities:



You can find all  
information on the web on  
our article detail page



Would you like individual advice?

We look forward to your email to [products@ettinger.de](mailto:products@ettinger.de).

Subject to change and errors.