

Article datasheet

Butt Connector DIN 46341 1.5-2.5mm² Copper tinned without insulation

Article-No.: 018.73.025

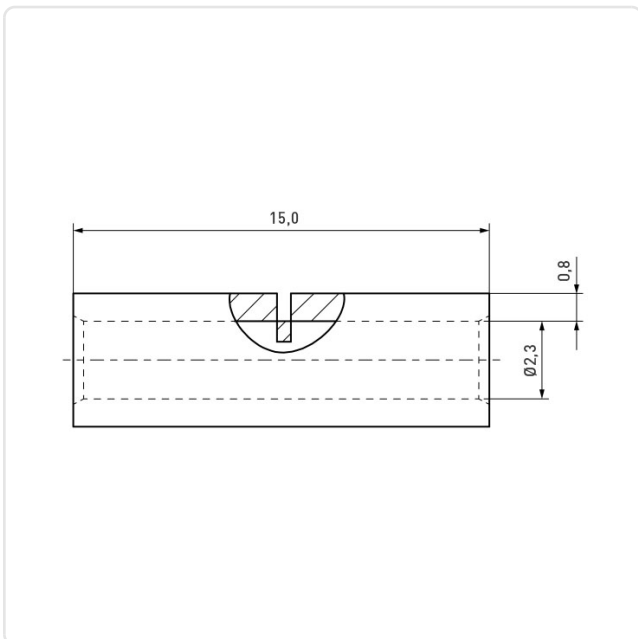

Image may be similar

DIN/ISO: DIN46341
Finish: Tin-Plated
Length [mm]: 14.5
Material: Electrolytic Copper
Wire Cross Section [mm²]: 1.5-2.5
Weight: 0.99g
Conformities:



You can find all
information on the web on
our article detail page



Would you like individual advice?

We look forward to your email to products@ettinger.de.

Subject to change and errors.