

Article datasheet

Flanged Bearing $\varnothing 6/9/12 \times 6$ -2mm Polyamid 6.6 natural UL94-V2

Article-No.: 005.99.067

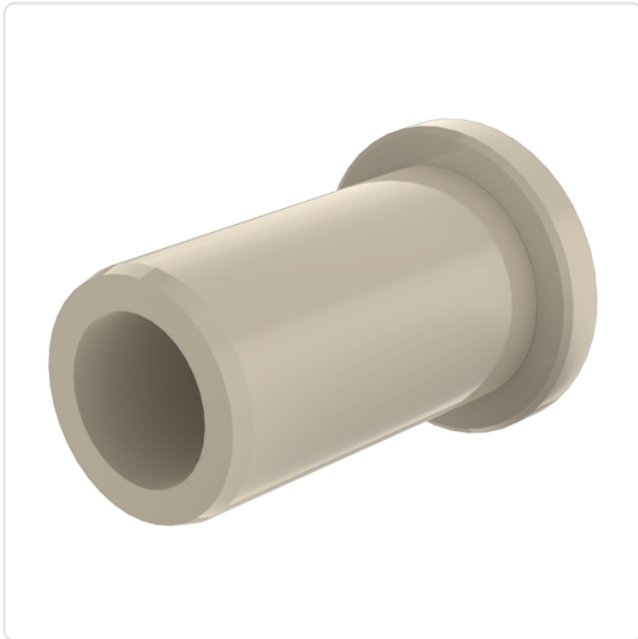

Image may be similar

Color: Natural
Flammability Class: UL94-V2
Inner Diameter [mm]: 6
Length [mm]: 6
Lug Diameter [mm]: 9
Material: PA 6.6
Material Group: Plastic
Model: With High Lug
Outer Diameter [mm]: 12
Weight: 0.34g
Conformities:



You can find all information on the web on our article detail page

Would you like individual advice?

We look forward to your email to products@ettinger.de.

Subject to change and errors.

