

Article datasheet

## Weld Nut DIN929 M10 A4 Plain Stainless Steel Hexagon

Article-No.: 002.31.109

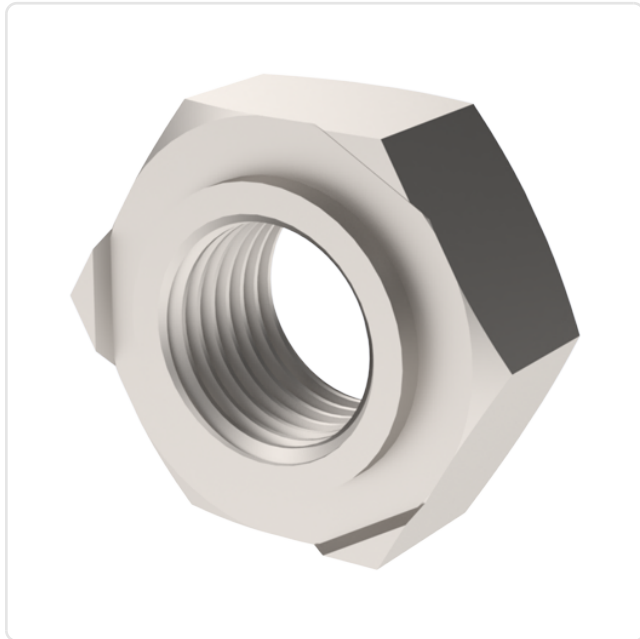
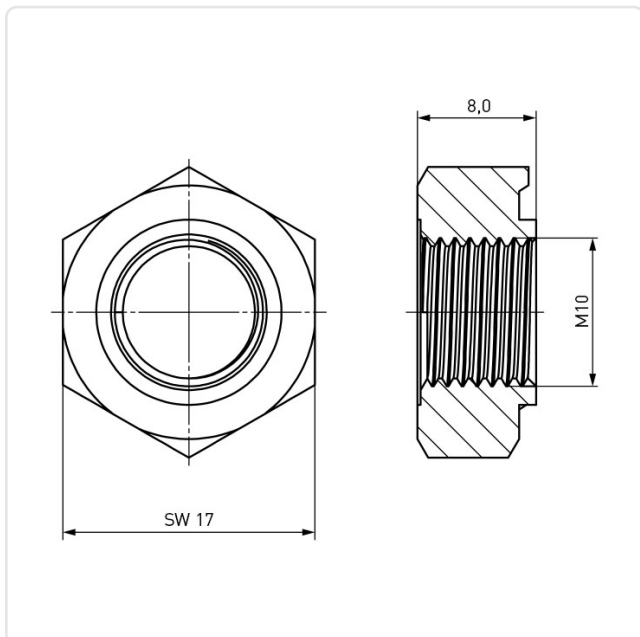

Image may be similar

AF / OD [mm]: 17  
DIN/ISO: DIN929  
Finish: Plain  
Height [mm]: 8  
Material: Stainless Steel AISI 316 / A4  
Thread Size: M10  
Conformities:



You can find all  
information on the web on  
our article detail page



Would you like individual advice?

We look forward to your email to [products@ettinger.de](mailto:products@ettinger.de).

Subject to change and errors.