

Article datasheet

PCB Support 10.0 | M3 | ø4.0 Polyamide 6.6 black

Article-No.: 006.53.106

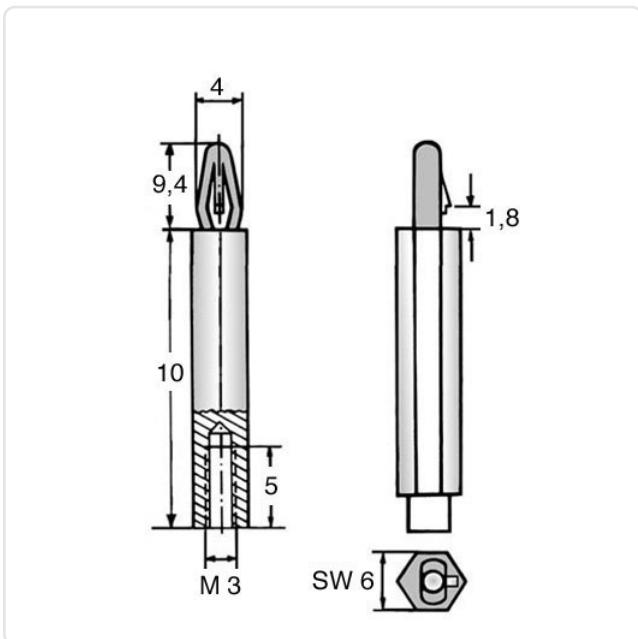

Image may be similar

Color: Black
Flammability Class: UL94-HB
Length [mm]: 10
Material: PA 6.6
PCB Hole Ø [mm]: 4
PCB Thickness [mm]: 1,6
Thread Size: M3
Weight: 0.36g
Conformities:



You can find all information on the web on our article detail page



Would you like individual advice?

We look forward to your email to products@ettinger.de.

Subject to change and errors.