

Article datasheet

## Insulated Standoff PA-Brass M/M AF6x5 | Thread M2.5x6 / M2.5x6

Article-No.: 005.41.622

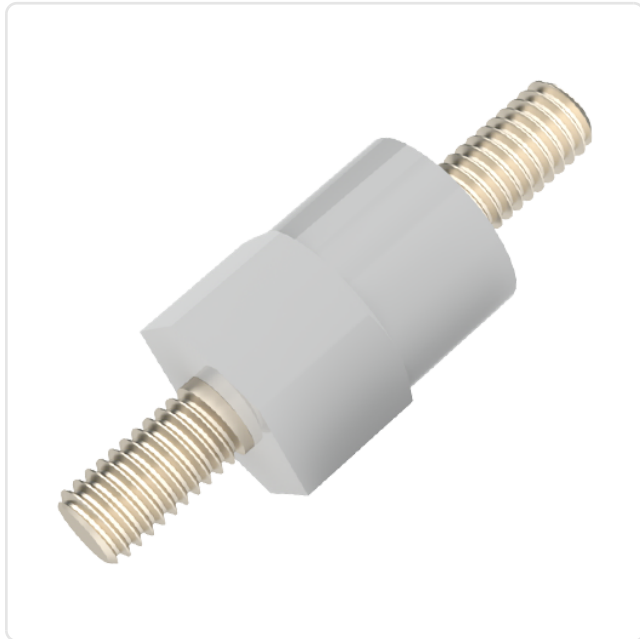

AF / OD [mm]:	6
Flammability Class:	UL94-HB
Length [mm]:	5
Material:	PA 6.6
Material Group:	Plastic
Profile:	Hexagonal
Thread 1 Length [mm]:	6
Thread 1 Size:	M2.5
Thread 2 Length [mm]:	6
Thread 2 Size:	M2.5
Thread Insert Material:	Brass
Weight:	0.77g
Conformities:	



Image may be similar

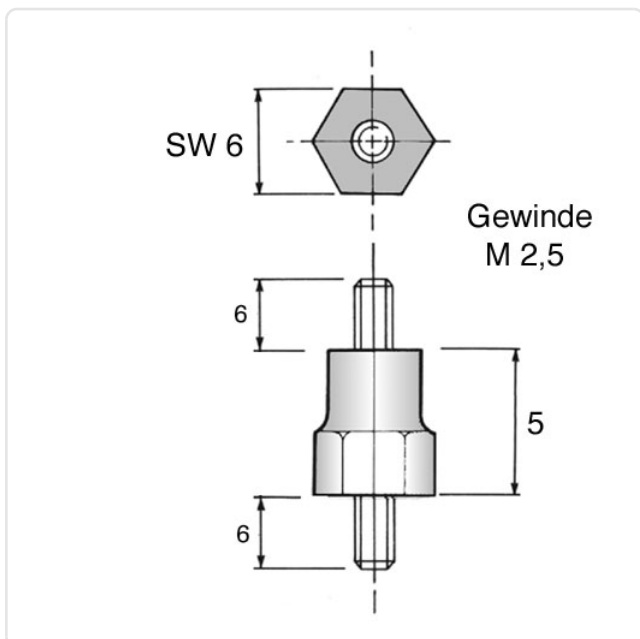

You can find all information on the web on our article detail page

Would you like individual advice?

We look forward to your email to [products@ettinger.de](mailto:products@ettinger.de).

Subject to change and errors.