

Article datasheet

End-Sleeve DIN 46228 0.75mm²/10mm E-Copper tinned

Article-No.: 018.92.075

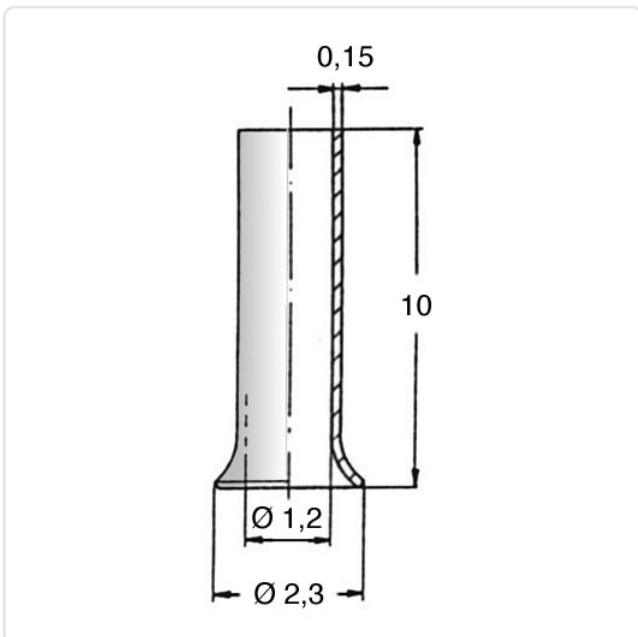

Image may be similar

Color:	Silver
Finish:	Tin-Plated
Length [mm]:	10
Material:	Electrolytic Copper
Material Group:	Copper
Wire Cross Section [mm ²]:	0.75
Weight:	0.06g
Conformities:	



You can find all
information on the web on
our article detail page



Would you like individual advice?

We look forward to your email to products@ettinger.de.

Subject to change and errors.