

Article datasheet

## Retaining Ring Ø2.3/6.0 x 1.0 POM black

Article-No.: 003.15.202

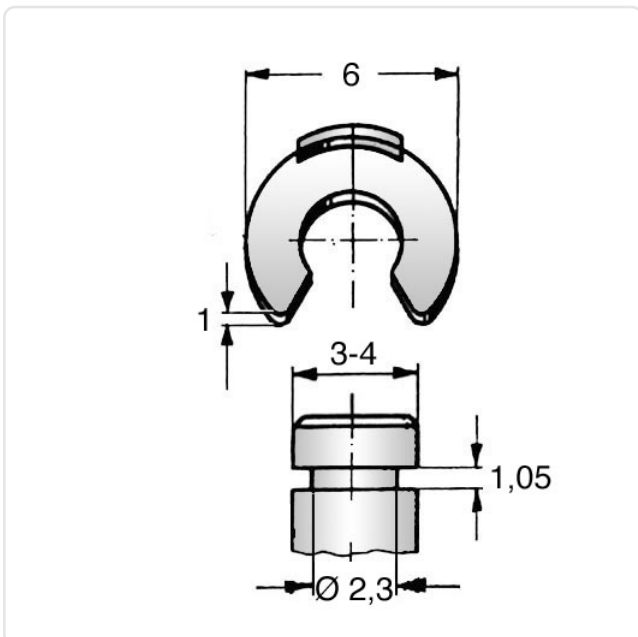

Image may be similar

Color: Black  
Height [mm]: 1  
Inner Diameter [mm]: 2.3  
Material: POM - Polyoxymethylene  
Material Group: Plastic  
Outer Diameter [mm]: 6  
Weight: 0.03g  
Conformities:



You can find all information on the web on our article detail page



Would you like individual advice?

We look forward to your email to [products@ettinger.de](mailto:products@ettinger.de).

Subject to change and errors.