

Article datasheet

## PCB Support 7.9 Self-Adhesive Polyamide 6.6 natural

Article-No.: 006.21.807

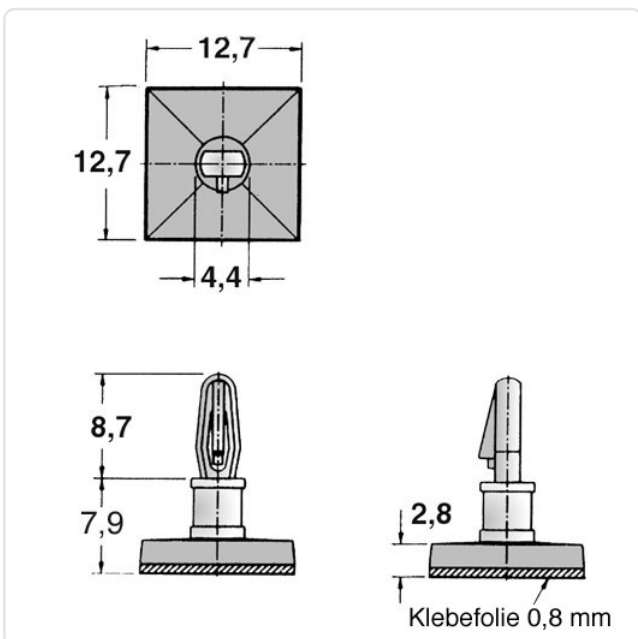

Image may be similar

Color: Natural  
Flammability Class: UL94-V2  
Length [mm]: 7.9  
Material: PA 6.6  
PCB Hole Ø [mm]: 3.2  
PCB Thickness [mm]: 1,6  
Weight: 0.57g  
Conformities:



You can find all  
information on the web on  
our article detail page



Would you like individual advice?

We look forward to your email to [products@ettinger.de](mailto:products@ettinger.de).

Subject to change and errors.