

Article datasheet

## PCB Support 18.0 | M3 | ø4.0 Polyamide 6.6 black

Article-No.: 006.53.186

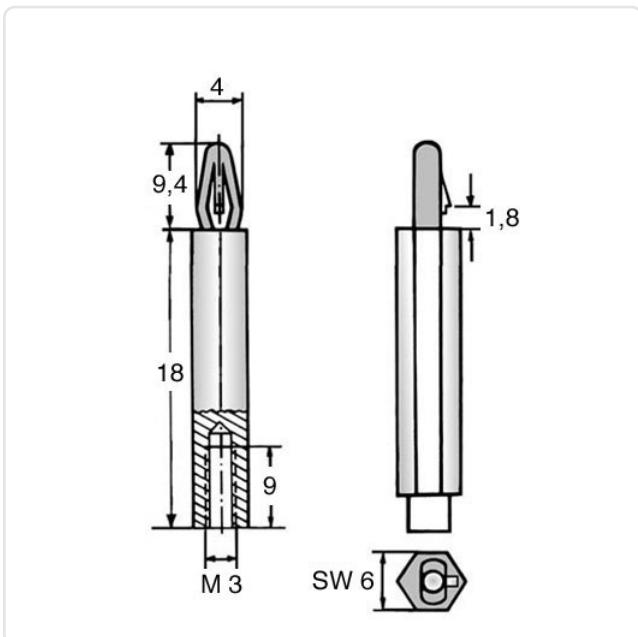

Image may be similar

Color: Black  
Flammability Class: UL94-HB  
Length [mm]: 18  
Material: PA 6.6  
PCB Hole Ø [mm]: 4  
PCB Thickness [mm]: 1,6  
Thread Size: M3  
Weight: 0.6g  
Conformities:



You can find all information on the web on our article detail page



Would you like individual advice?

We look forward to your email to [products@ettinger.de](mailto:products@ettinger.de).

Subject to change and errors.