

Article datasheet

## Standoff Galvanized Steel Self-Tapping AF5x10 F=M2.5x7 M=ST2.6x5 w/o UC

Article-No.: 005.20.210



AF / OD [mm]:	5
Female Thread Length [mm]:	7
Female Thread Size:	M2.5
Finish:	Galvanized, Blue, 5 µm, A2K
Length [mm]:	10
Male Thread Length [mm]:	5
Male Thread Size:	ST2.6 Self-Tapping
Material:	Steel AISI 12L13 / 11SMnPb30
Material Group:	Steel
Profile:	Hexagonal
Undercut:	No
Weight:	1.5g
Conformities:	



Image may be similar

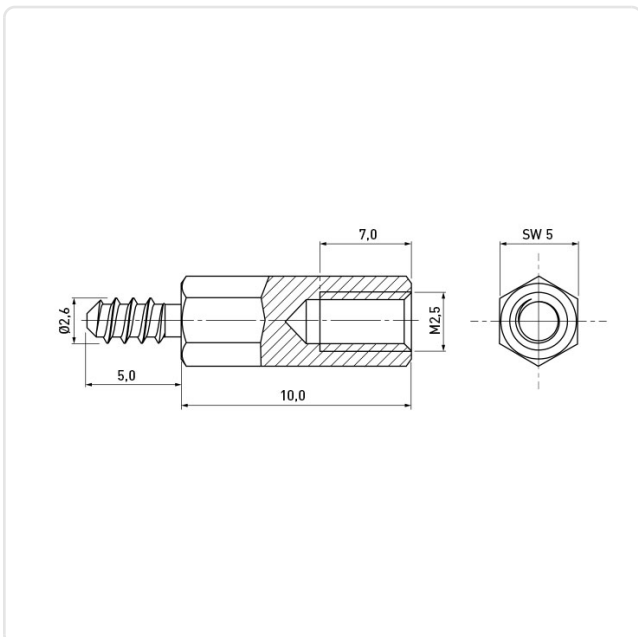

You can find all information on the web on our article detail page

Would you like individual advice?

We look forward to your email to [products@ettinger.de](mailto:products@ettinger.de).

Subject to change and errors.