

Article datasheet

Nut for T-Slot DIN508 M20x22 Plain Steel 10

Article-No.: 002.04.201

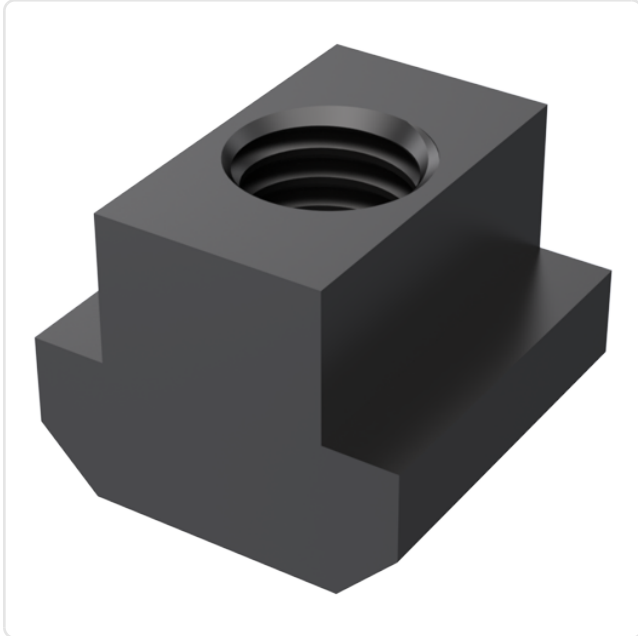

Image may be similar

DIN/ISO: DIN508
Finish: Plain
Head Height [mm]: 14
Height [mm]: 28
Length [mm]: 35
Material: Steel - Grade 10
Slot Width [mm]: 22
Thread Size: M20
Conformities:



You can find all information on the web on our article detail page

Would you like individual advice?

We look forward to your email to products@ettinger.de.

Subject to change and errors.

