

Article datasheet

Interlocking Hose Clamp Ø22.0-25.0 Polyamide 6.6 black

Article-No.: 014.44.250

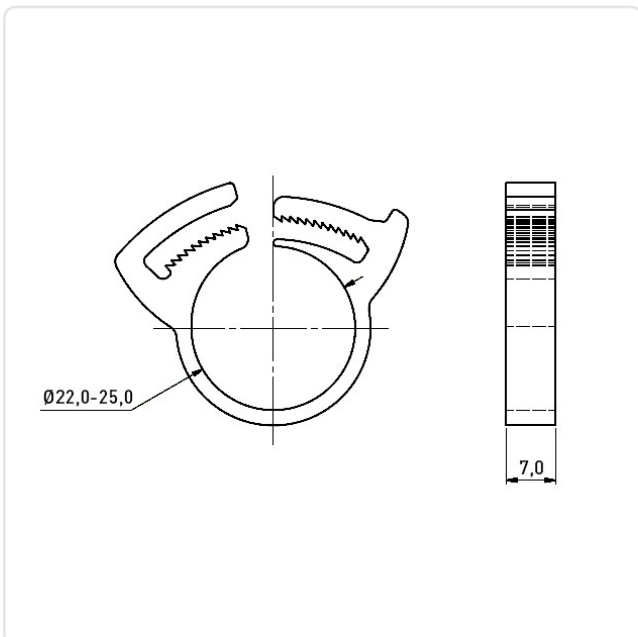

Image may be similar

Color:	Black
Flammability Class:	UL94-V2
Material:	PA 6.6
Panel Thickness Range [mm]:	22,0-25,0
Thickness [mm]:	1.8
Width [mm]:	7
Weight:	3.37g
Conformities:	



You can find all
information on the web on
our article detail page



Would you like individual advice?

We look forward to your email to products@ettinger.de.

Subject to change and errors.