

Article datasheet

Solder terminal 2.8x7.5mm Bronze tinned 0.5mm thick

Article-No.: 013.13.870

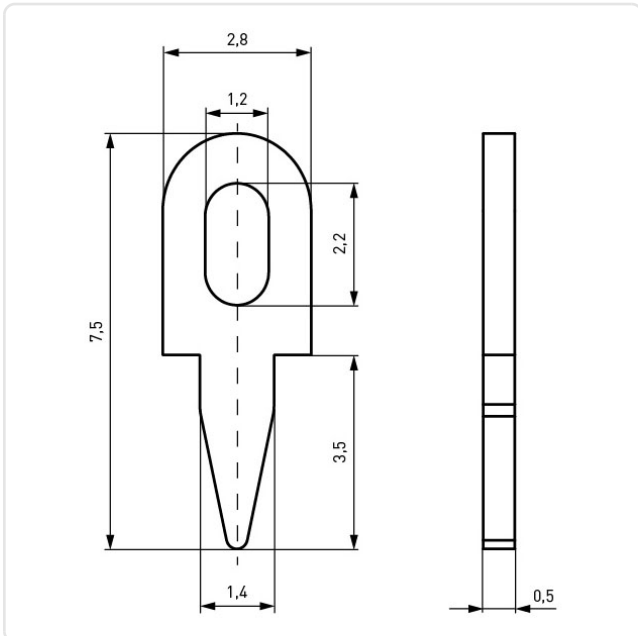

Image may be similar

Diameter [mm]: 2.8
Finish: Tin-Plated
Length [mm]: 7.5
Material: Bronze
Material Group: Bronze
Model: flat
PCB Hole Ø [mm]: 1.3
Weight: 0.05g
Conformities:



You can find all information on the web on our article detail page



Would you like individual advice?

We look forward to your email to products@ettinger.de.

Subject to change and errors.