

Article datasheet

## Hole Plug $\varnothing 4.4/9.0$ mm Polyethylene, natural/Not UL-listed

Article-No.: 014.10.033

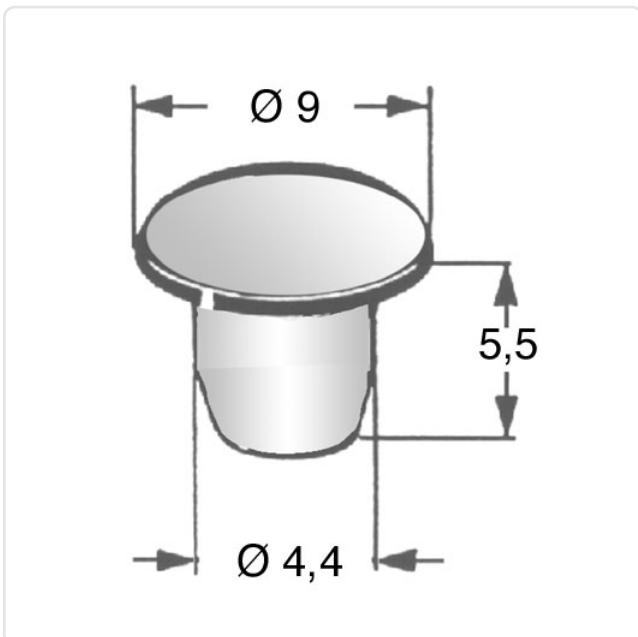

Image may be similar

Color: Natural  
Inner Diameter [mm]: 4.4  
Material: PE - Polyethylene  
Material Group: Plastic  
Model: Hole Plug  
Outer Diameter [mm]: 9  
Weight: 0.09g  
Conformities:



You can find all  
information on the web on  
our article detail page



Would you like individual advice?

We look forward to your email to [products@ettinger.de](mailto:products@ettinger.de).

Subject to change and errors.