

Article datasheet

LED-Mount for Rectangular LED 3.0mm PVC black UL94-V0

Article-No.: 063.11.030

Manufacturer: BIVAR

Manufacturer article-no.: ERM 1-3MM

BIVAR

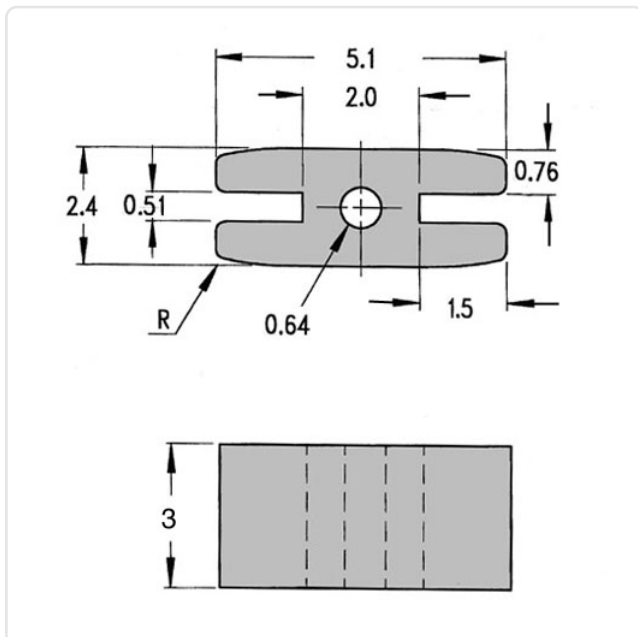

Image may be similar

Color: Black
Flammability Class: UL94-V0
Length [mm]: 3
Material: PVC - Polyvinyl Chloride
Material Group: Plastic
Width [mm]: 5.1
Weight: 0.04g
Conformities:



You can find all information on the web on our article detail page



Would you like individual advice?

We look forward to your email to products@ettinger.de.

Subject to change and errors.