

Article datasheet

Swage Standoff M4x6.0 Galvanized Steel

Article-No.: 004.66.421

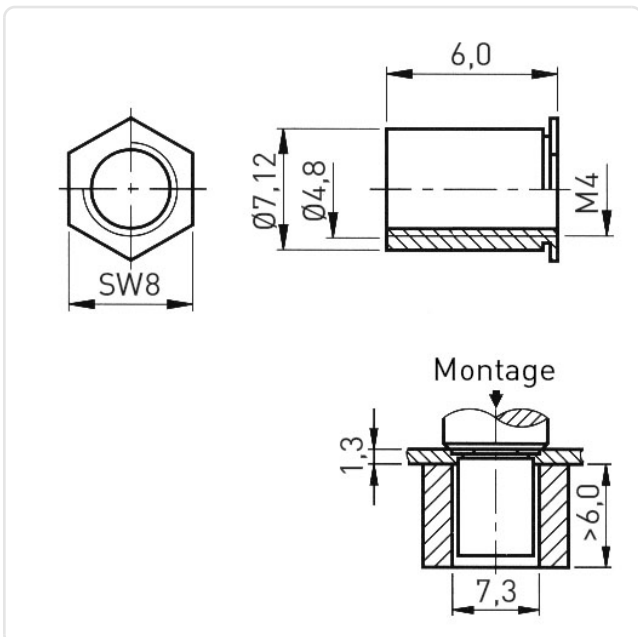

Image may be similar

AF / OD [mm]:	8
Area of Application:	For Metallic Materials
Finish:	Galvanized, Blue, 5 µm, A2K
Length [mm]:	6
Material:	Case-Hardened Steel
Minimum Edge Distance [mm]:	8.0
Outer Diameter [mm]:	7.12
Panel Hole Ø [mm]:	7.14
Panel Thickness [mm]:	1,3
Thread Size:	M4
Weight:	1.3g
Conformities:	



You can find all information on the web on our article detail page



Would you like individual advice?

We look forward to your email to products@ettinger.de.

Subject to change and errors.