

Article datasheet

Hole Grommet 2.0/5.0-1.0mm PVC black

Article-No.: 014.60.020

Manufacturer: SES-Sterling

Manufacturer article-no.: 0107 0001 010

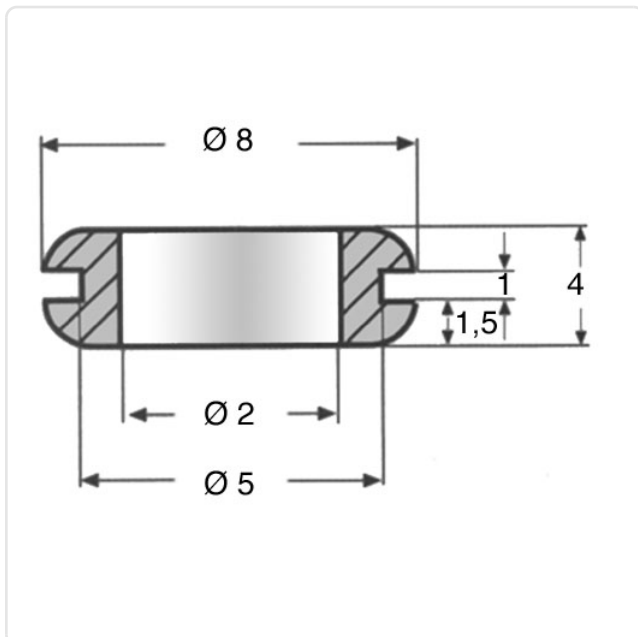

Image may be similar

Color:	Black
Inner Diameter [mm]:	2
Material:	PVC - Polyvinyl Chloride
Material Group:	Plastic
Max. Panel Thickness [mm]:	1
Mounting Hole [mm]:	5
Weight:	0.2g
Conformities:	



You can find all
information on the web on
our article detail page



Would you like individual advice?

We look forward to your email to products@ettinger.de.

Subject to change and errors.