

Article datasheet

Swage Standoff $\varnothing 3.6 \times 3.0$ Tin-Plated Steel

Article-No.: 004.61.705

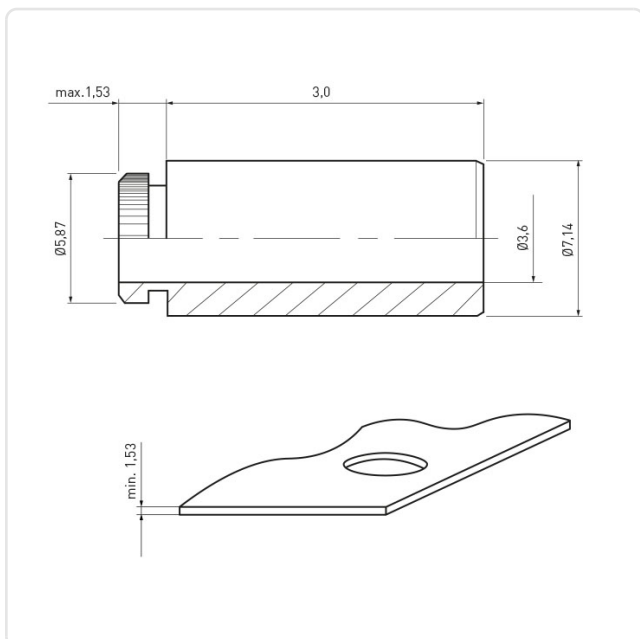

Image may be similar

Area of Application:	For Plastics
Finish:	Tin-Plated
Inner Diameter [mm]:	3.6
Length [mm]:	3
Material:	Steel
Minimum Edge Distance [mm]:	5,5
Outer Diameter [mm]:	7.1
Panel Hole \varnothing [mm]:	5.4
Panel Thickness [mm]:	1,5
Weight:	0.84g
Conformities:	



You can find all
information on the web on
our article detail page



Would you like individual advice?

We look forward to your email to products@ettinger.de.

Subject to change and errors.