

Article datasheet

Insulated Standoff PA-Brass F/F $\varnothing 6.5 \times 50$ | Thread M3x6 / M3x6

Article-No.: 005.48.350



Image may be similar

AF / OD [mm]:	6.5
Flammability Class:	UL94-HB
Length [mm]:	50
Material:	PA 6.6
Material Group:	Plastic
Profile:	Round
Thread 1 Length [mm]:	6
Thread 1 Size:	M3
Thread 2 Length [mm]:	6
Thread 2 Size:	M3
Thread Insert Material:	Brass
Weight:	2.23g
Conformities:	

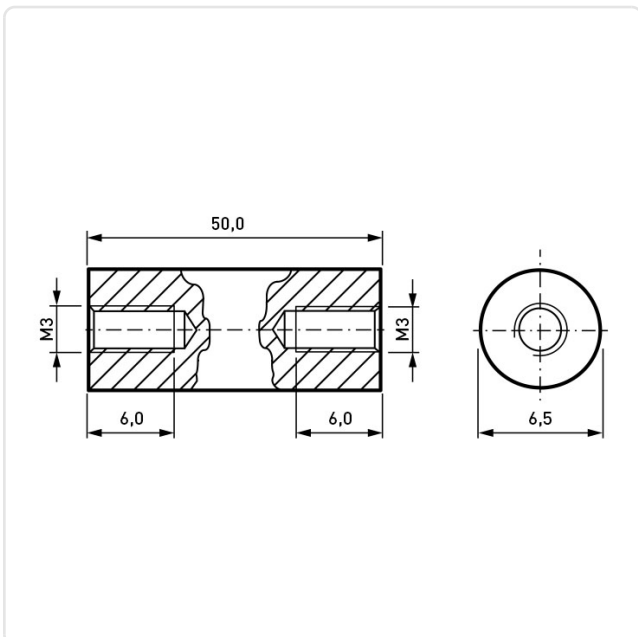

You can find all
information on the web on
our article detail page

Would you like individual advice?

We look forward to your email to products@ettinger.de.

Subject to change and errors.