

Article datasheet

Retaining Ring Ø2.5/6.0 x 2.0 POM red

Article-No.: 003.15.103

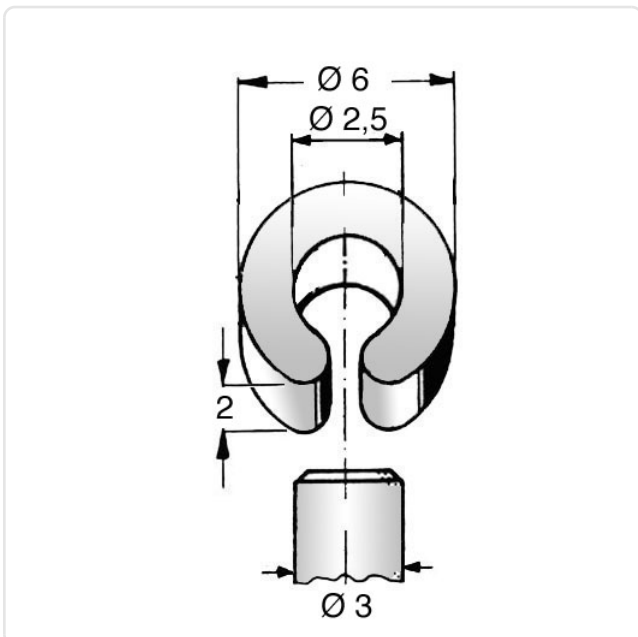

Image may be similar

Color: Red
Height [mm]: 2
Inner Diameter [mm]: 2.5
Material: POM - Polyoxymethylene
Material Group: Plastic
Outer Diameter [mm]: 6
Weight: 0.06g
Conformities:



You can find all
information on the web on
our article detail page



Would you like individual advice?

We look forward to your email to products@ettinger.de.

Subject to change and errors.