

Article datasheet

Combination Nut M6 Galvanized Steel 8.8 Toothed Lock Washer

Article-No.: 002.29.661

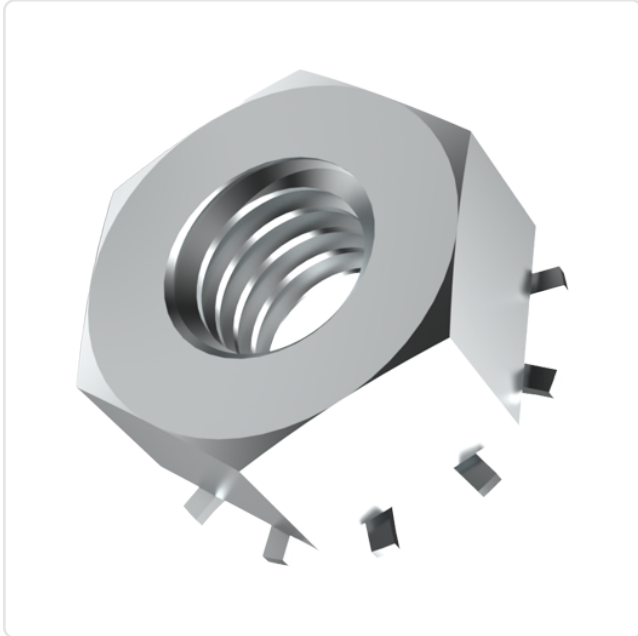
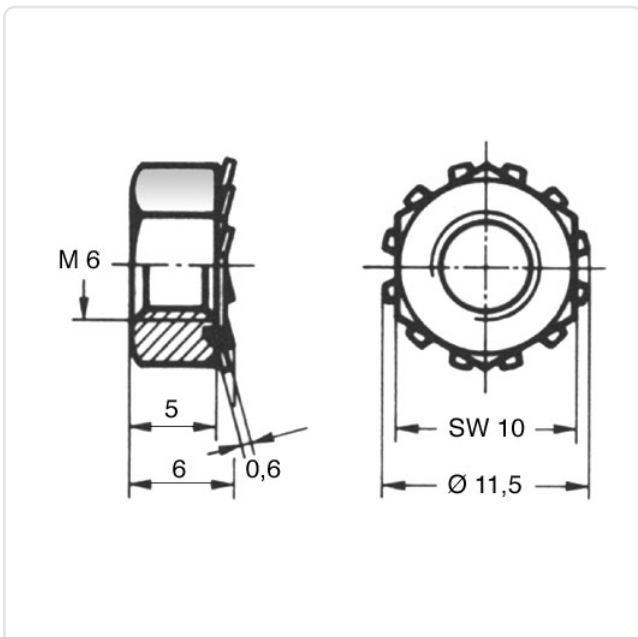

Image may be similar

AF / OD [mm]: 10
Finish: Galvanized, Blue, 5 µm, A2K
Height [mm]: 6
Material: Steel 8.8
Material Group: Steel
Thread Size: M6
Weight: 2.44g
Conformities:



You can find all
information on the web on
our article detail page



Would you like individual advice?

We look forward to your email to products@ettinger.de.

Subject to change and errors.