

Article datasheet

Self-Clinching Stud M3x12.0 Tin-Plated Phosphor Bronze

Article-No.: 004.67.365



Image may be similar

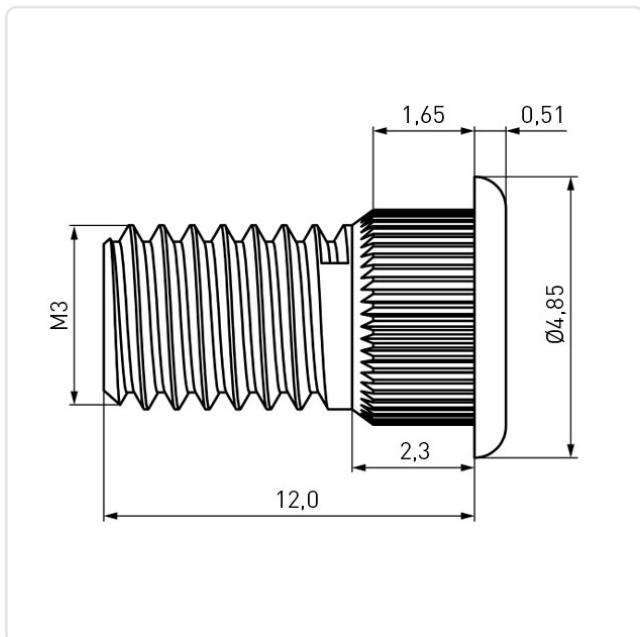

Area of Application:	For Plastics
Finish:	Tin-Plated
Head Diameter [mm]:	4.58
Length [mm]:	12
Material:	Phosphor Bronze
Minimum Edge Distance [mm]:	3.1
Panel Hole Ø [mm]:	3
Panel Thickness [mm]:	1,5
Thread Size:	M3
Weight:	0.74g
Conformities:	



You can find all information on the web on our article detail page

Would you like individual advice?

We look forward to your email to products@ettinger.de.

Subject to change and errors.