

Article datasheet

Captive Screw M2.5x8 Flat Head Nickel-Plated Steel 4.8 Slotted

Article-No.: 001.82.233

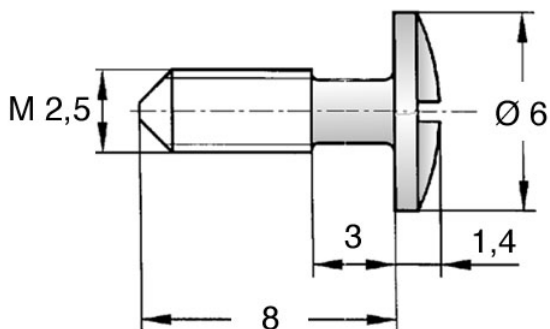

Image may be similar

Drive Type:	Slotted
Finish:	Nickel-Plated, 3 µm, E1E
Head Diameter [mm]:	6
Head Height [mm]:	1.4
Head Shape:	Pan Head
Length [mm]:	8
Material:	Steel 4.8
Material Group:	Steel
Reduced Shank Length [mm]:	3
Thread Size:	M2.5
Weight:	0.46g
Conformities:	



You can find all information on the web on our article detail page



Would you like individual advice?

We look forward to your email to products@ettinger.de.

Subject to change and errors.