

Article datasheet

## Drive Fastener $\varnothing 3.9/1.0-5.0$ mm panel Polyoxymethylene(POM),natural

Article-No.: 072.17.741

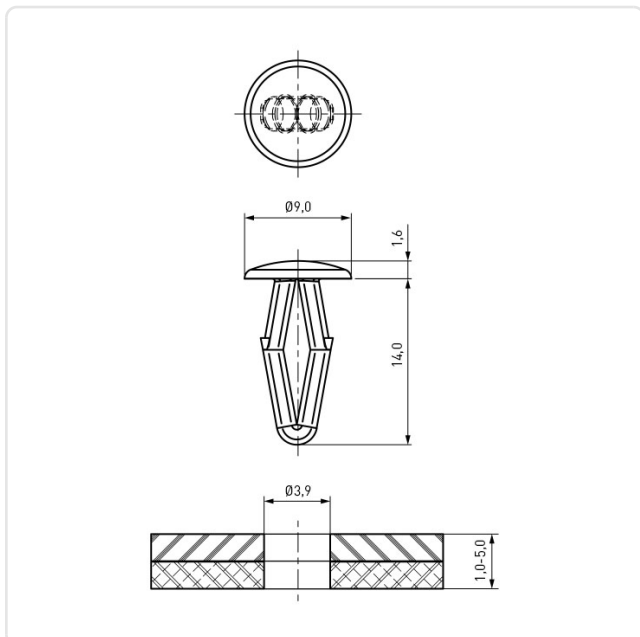

Image may be similar

Color:	Natural
Head Diameter [mm]:	9
Material:	POM - Polyoxymethylene
Material Group:	Plastic
Mounting Hole [mm]:	3.9
Panel Thickness Range [mm]:	1.0 - 5.0
Weight:	0.24g
Conformities:	



You can find all information on the web on our article detail page



Would you like individual advice?

We look forward to your email to [products@ettinger.de](mailto:products@ettinger.de).

Subject to change and errors.