

Article datasheet

Lock Nut DIN985/ISO10511 M5 Galvanized Steel

Article-No.: 002.08.105

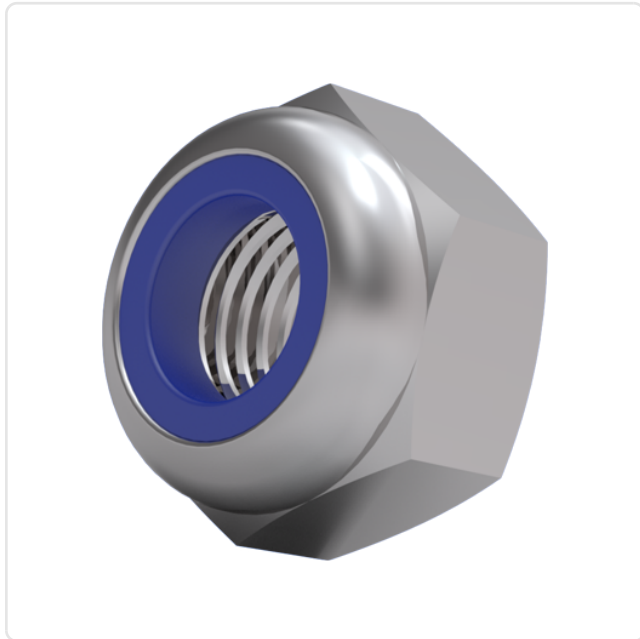
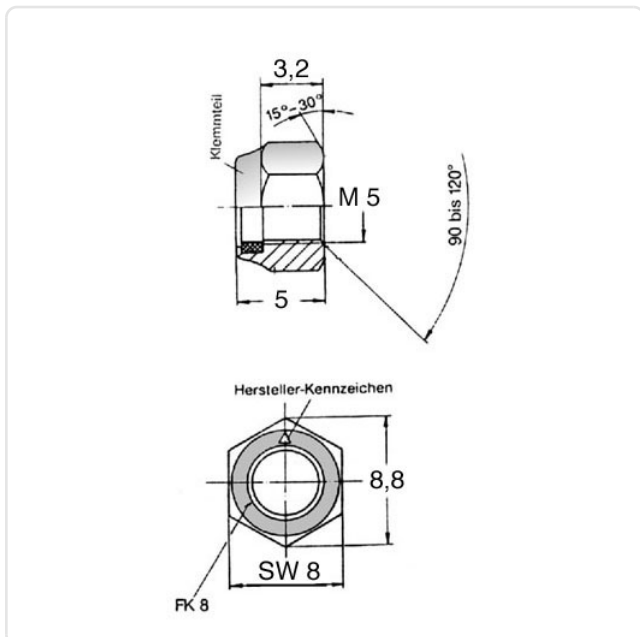

Image may be similar

AF / OD [mm]: 8
DIN/ISO: DIN985 / ISO10511
Finish: Galvanized, Blue, 5 µm, A2K
Height [mm]: 5
Material: Steel
Material Group: Stahl
Thread Size: M5
Weight: 1.05g
Conformities:



You can find all
information on the web on
our article detail page



Would you like individual advice?

We look forward to your email to products@ettinger.de.

Subject to change and errors.