

Article datasheet

Nut for T-Slot DIN508 M6x8 Plain Steel 10

Article-No.: 002.04.061

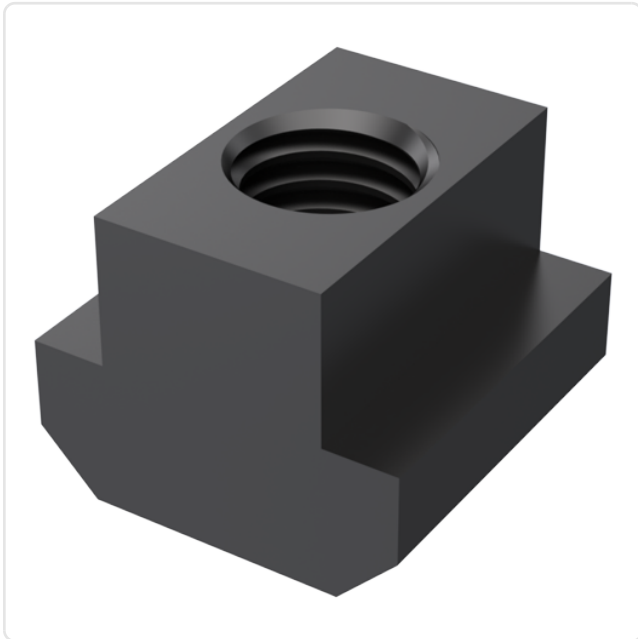
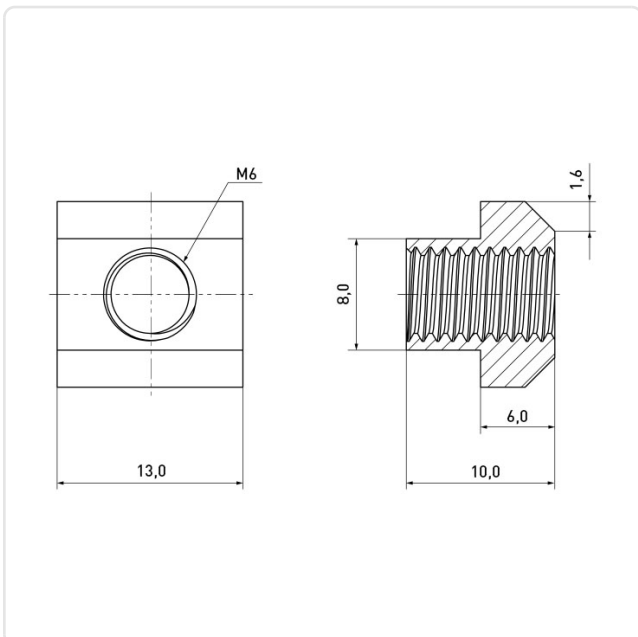

Image may be similar

DIN/ISO: DIN508
Finish: Plain
Head Height [mm]: 6
Height [mm]: 10
Length [mm]: 13
Material: Steel - Grade 10
Slot Width [mm]: 8
Thread Size: M6
Conformities:



You can find all information on the web on our article detail page



Would you like individual advice?

We look forward to your email to products@ettinger.de.

Subject to change and errors.