

Article datasheet

Nut for T-Slot DIN508 M12x14 Plain Steel 10

Article-No.: 002.04.121

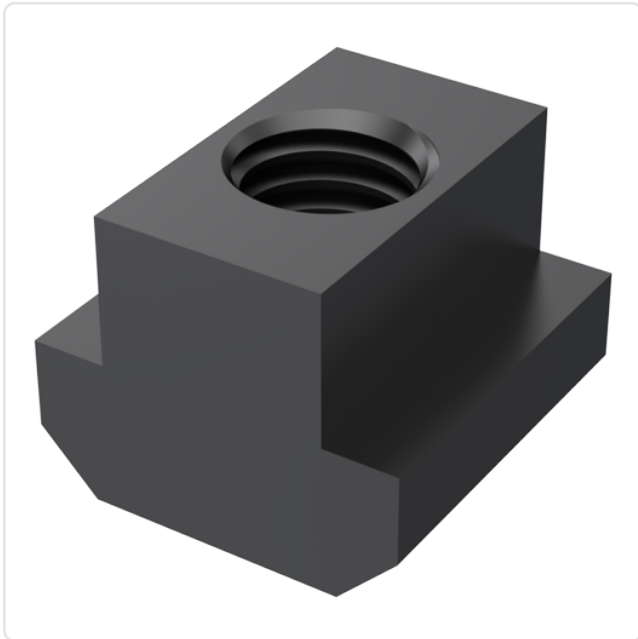

Image may be similar

DIN/ISO:	DIN508
Finish:	Plain
Head Height [mm]:	8
Height [mm]:	16
Length [mm]:	22
Material:	Steel - Grade 10
Slot Width [mm]:	14
Thread Size:	M12
Conformities:	



You can find all information on the web on our article detail page

Would you like individual advice?

We look forward to your email to products@ettinger.de.

Subject to change and errors.

