

Article datasheet

Cheese Head Screw ISO1207 M2.5x4 Nickel-Plated Steel 4.8 Slotted

Article-No.: 001.14.203

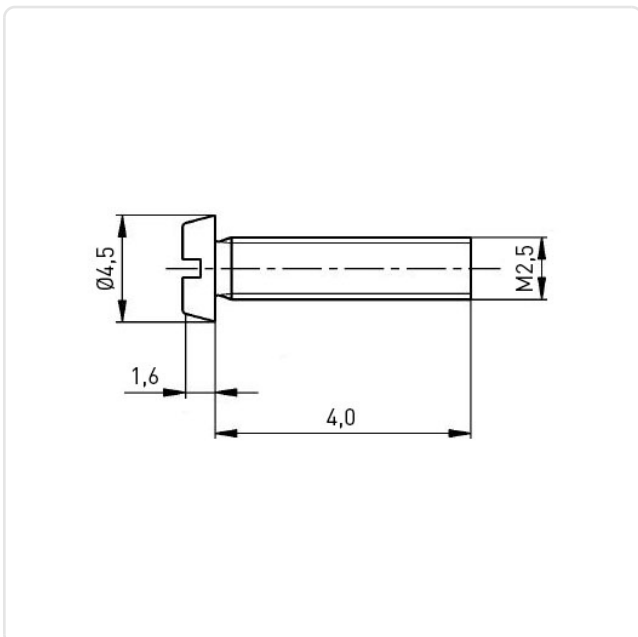

Image may be similar

DIN/ISO:	DIN84 / ISO1207
Drive Type:	Slotted
Finish:	Nickel-Plated, 3 µm, E1E
Head Diameter [mm]:	4.5
Head Height [mm]:	1.6
Head Shape:	Cheese Head
Length [mm]:	4
Material:	Steel 4.8
Material Group:	Steel
Thread Size:	M2.5
Weight:	0.27g
Conformities:	



You can find all information on the web on our article detail page



Would you like individual advice?

We look forward to your email to products@ettinger.de.

Subject to change and errors.