

Article datasheet

Snap Lock Pin SLP-2 4.5mm Polyamid 6.6,natural UL94-V2 E70062

Article-No.: 072.12.045

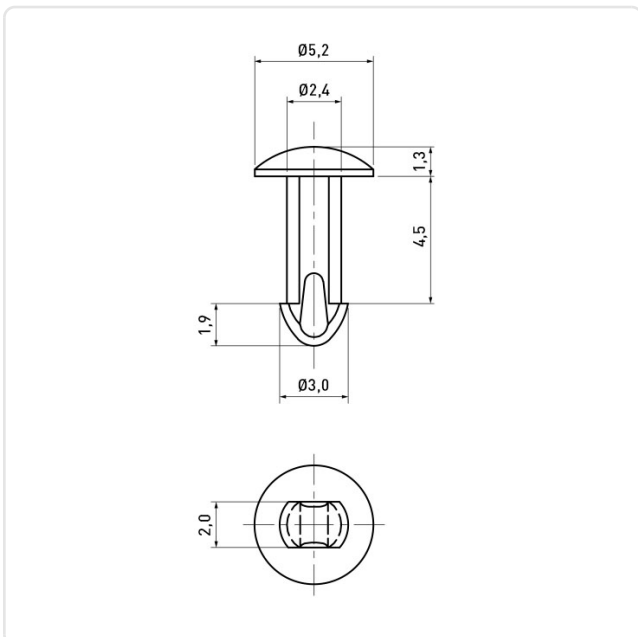

Image may be similar

Color: Natural
Flammability Class: UL94-V2
Head Diameter [mm]: 5.2
Material: PA 6.6
Material Group: Plastic
Mounting Hole [mm]: 2.4
Weight: 0.05g
Conformities:



You can find all
information on the web on
our article detail page



Would you like individual advice?

We look forward to your email to products@ettinger.de.

Subject to change and errors.