

Article datasheet

PCB Support 19.1 | \varnothing 4.0 | \varnothing 4.1 Polyamide 6.6 natural

Article-No.: 006.64.196

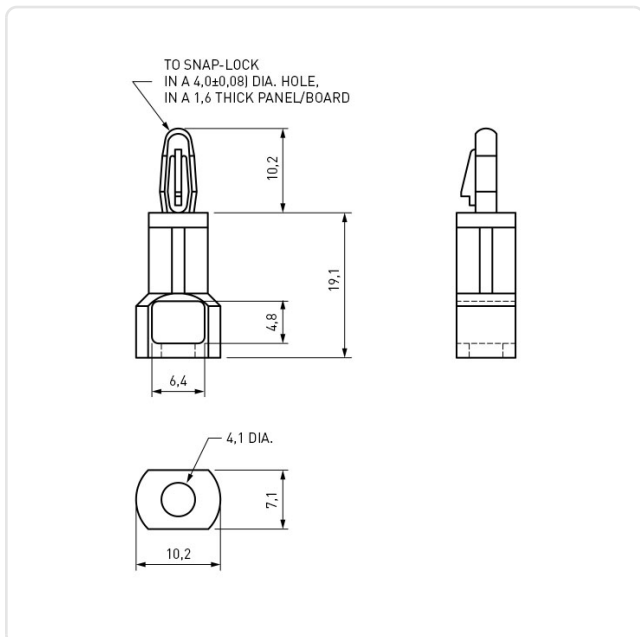

Image may be similar

Color: Natural
Flammability Class: UL94-V2
Length [mm]: 19.1
Material: PA 6.6
PCB Hole \varnothing [mm]: 4
PCB Thickness [mm]: 1,6
Panel Hole \varnothing [mm]: 4.1
Weight: 0.63g
Conformities:



You can find all information on the web on our article detail page



Would you like individual advice?

We look forward to your email to products@ettinger.de.

Subject to change and errors.