

Article datasheet

Long Nut M30 DIN6334 A4 Stainless Steel AF 46x90 / M30

Article-No.: 002.20.309

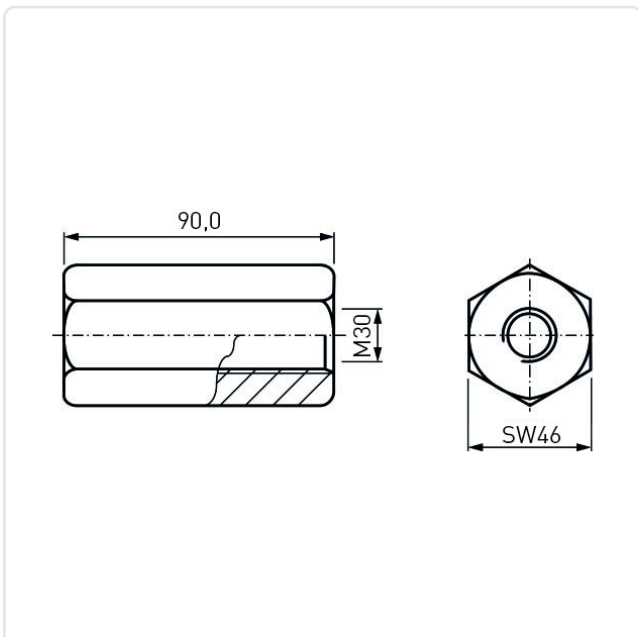

Image may be similar

DIN/ISO: DIN6334
Finish: Plain
Length [mm]: 90
Material: Stainless Steel AISI 316 / A4
Material Group: Stainless Steel
Profile: Hexagonal
Thread Size: M30
Conformities:



You can find all
information on the web on
our article detail page



Would you like individual advice?

We look forward to your email to products@ettinger.de.

Subject to change and errors.