

Article datasheet

## Insulated Standoff PA-Brass M/F AF6.4x35 | F=M3x6 M=M3x6

Article-No.: 005.41.335



Image may be similar

AF / OD [mm]:	6.4
Female Thread Length [mm]:	6
Female Thread Size:	M3
Flammability Class:	UL94-HB
Length [mm]:	35
Male Thread Length [mm]:	6
Male Thread Size:	M3
Material:	PA 6.6
Material Group:	Plastic
Profile:	Hexagonal
Thread Insert Material:	Brass
Weight:	2.34g
Conformities:	

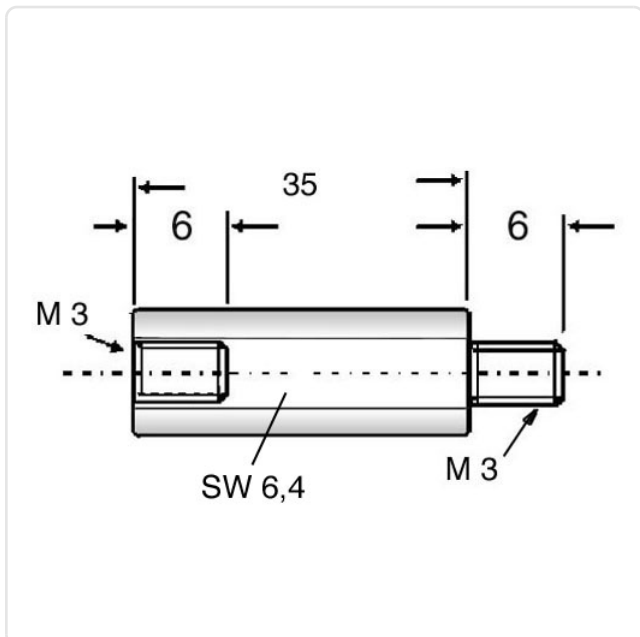

You can find all information on the web on our article detail page

Would you like individual advice?

We look forward to your email to [products@ettinger.de](mailto:products@ettinger.de).

Subject to change and errors.