

Article datasheet

PCB Support 9.5 | $\varnothing 4.0$ | $\varnothing 7.9$ Polyamide 6.6 natural

Article-No.: 006.67.096



Image may be similar

Color:	Natural
Flammability Class:	UL94-V2
Length [mm]:	9.5
Material:	PA 6.6
PCB Hole \varnothing [mm]:	4
PCB Thickness [mm]:	1,6
Panel Hole \varnothing [mm]:	7.9
Panel Thickness [mm]:	6,4
Weight:	0.62g
Conformities:	



You can find all information on the web on our article detail page

Top Hole: Snap-fit: 4
Panel Thickness: 1,57

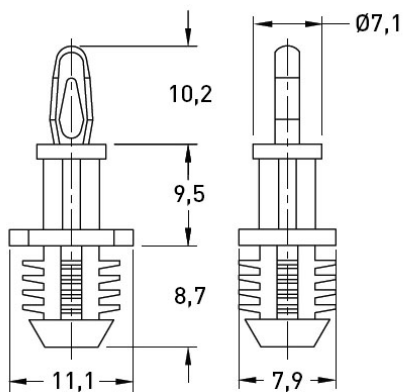

Bottom Hole: Press-fit: 7,92
Panel Thickness: 6,4 min.

Would you like individual advice?

We look forward to your email to products@ettinger.de.

Subject to change and errors.