

Article datasheet

Thread-Locking Screw ISO14583 M2.5x8 Galvanized Steel 8.8 Torx Blue PA Patch

Article-No.: 083.55.236

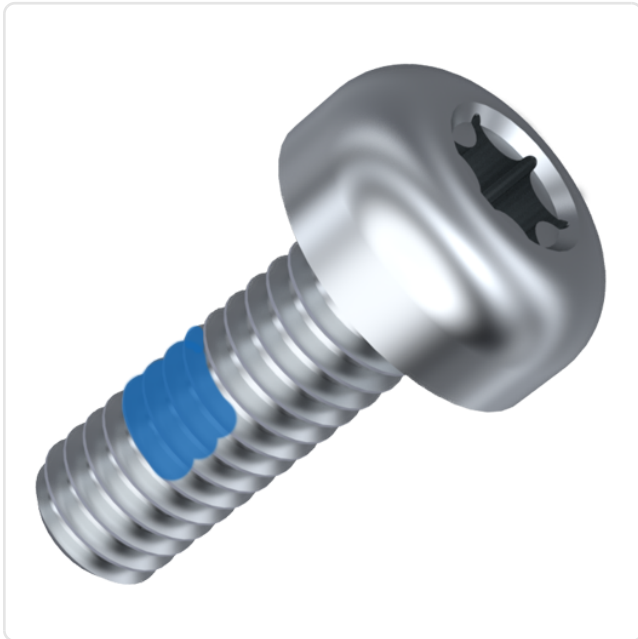
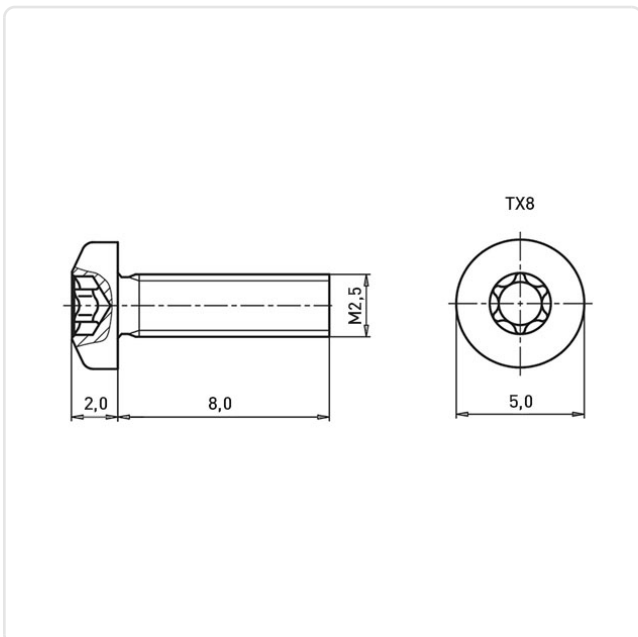

Image may be similar

Actuator Size:	Torx T8
DIN/ISO:	ISO14583
Drive Type:	TORX
Finish:	Galvanized, Blue, 5 µm, A2K
Head Diameter [mm]:	5
Head Height [mm]:	2.1
Head Shape:	Pan Head
Length [mm]:	8
Material:	Steel 8.8
Material Group:	Steel
Thread Locking:	Blue Nylon Patch
Thread Size:	M2.5
Weight:	0.44g
Conformities:	



You can find all
information on the web on
our article detail page

Would you like individual advice?

We look forward to your email to products@ettinger.de.

Subject to change and errors.