

Article datasheet

Drive Fastener $\varnothing 4.7/1.0-5.0$ mm panel Polyoxymethylene(POM),black

Article-No.: 072.17.750

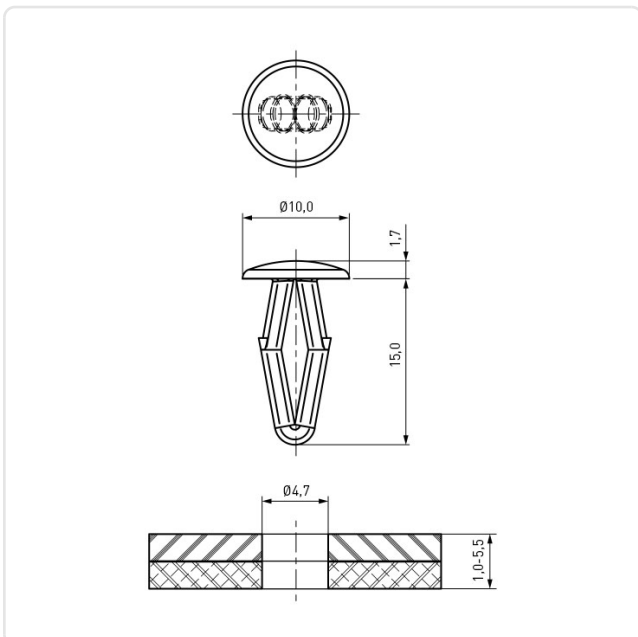

Image may be similar

Color:	Black
Head Diameter [mm]:	10
Material:	POM - Polyoxymethylene
Material Group:	Plastic
Mounting Hole [mm]:	4.7
Panel Thickness Range [mm]:	1.0 - 5.5
Weight:	0.31g
Conformities:	



You can find all information on the web on our article detail page



Would you like individual advice?

We look forward to your email to products@ettinger.de.

Subject to change and errors.