

Article datasheet

Interlocking Hose Clamp Ø17.0-18.5 Polyamide 6.6 black

Article-No.: 014.44.180

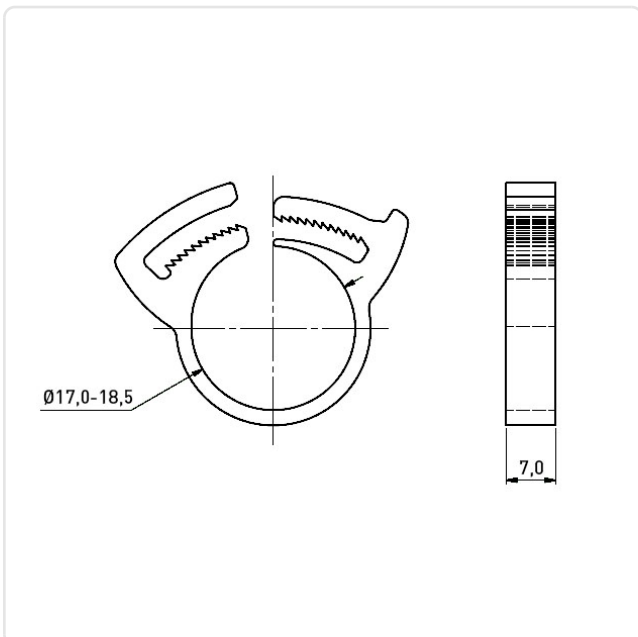

Image may be similar

Color:	Black
Flammability Class:	UL94-V2
Material:	PA 6.6
Panel Thickness Range [mm]:	17,0-18,5
Thickness [mm]:	1.8
Width [mm]:	7
Weight:	2.79g
Conformities:	



You can find all information on the web on our article detail page



Would you like individual advice?

We look forward to your email to products@ettinger.de.

Subject to change and errors.