

Article datasheet

Conical Spring Washer DIN6796/ISO10670 Ø3.2/7.0 x 0.6 Phosphated Spring Steel

Article-No.: 003.24.831

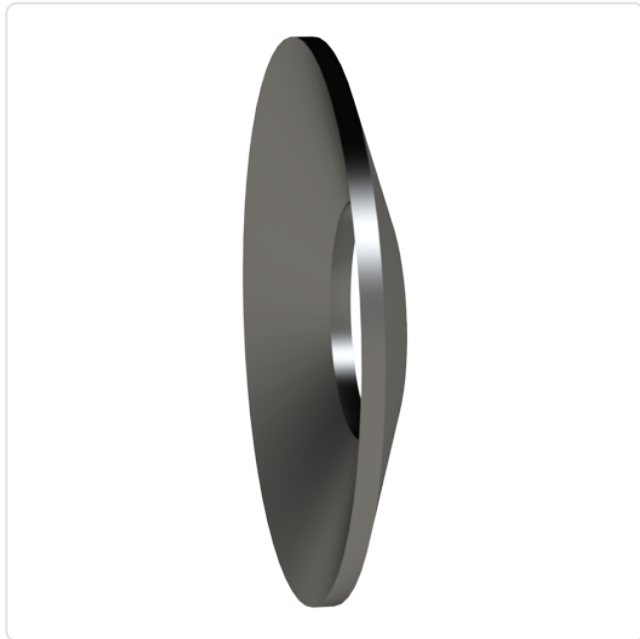
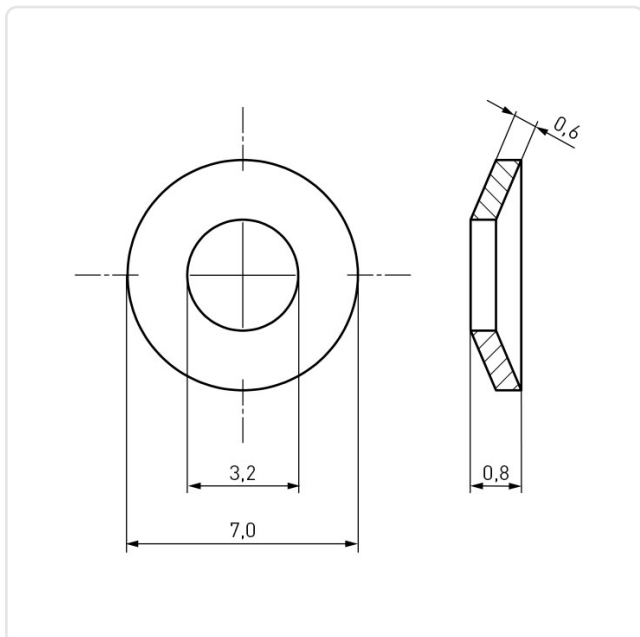

Image may be similar

DIN/ISO: DIN6796 / ISO10670
Finish: Phosphated
For Thread Size: M3
Height [mm]: 0.6
Inner Diameter [mm]: 3.2
Material: Spring Steel
Material Group: Steel
Outer Diameter [mm]: 7
Weight: 0.13g
Conformities:



You can find all
information on the web on
our article detail page



Would you like individual advice?

We look forward to your email to products@ettinger.de.

Subject to change and errors.