



Article datasheet

## Spring Washer DIN137 A Ø6.4/11.0 x 0.5 Galvanized Spring Steel

Article-No.: 003.22.061

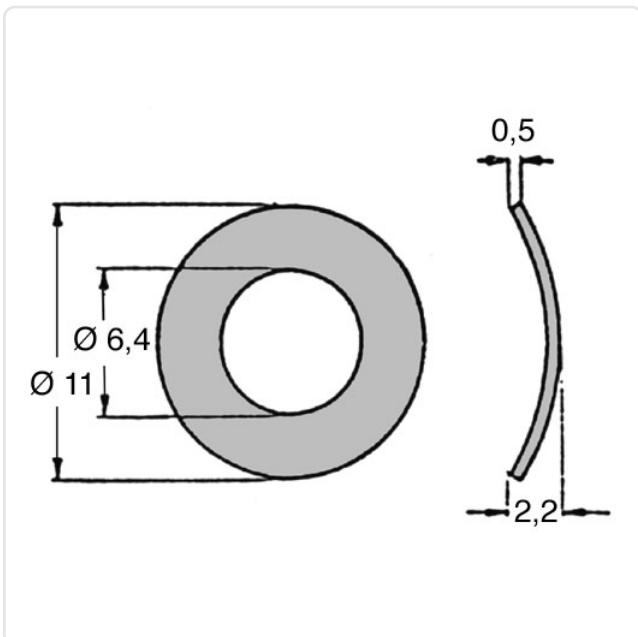

Image may be similar

DIN/ISO:	DIN137A
Finish:	Galvanized, Blue, 5 µm, A2K
For Thread Size:	M6
Height [mm]:	0.5
Inner Diameter [mm]:	6.4
Material:	Spring Steel
Material Group:	Steel
Outer Diameter [mm]:	11
Weight:	0.23g
Conformities:	  



You can find all  
information on the web on  
our article detail page



Would you like individual advice?

We look forward to your email to [products@ettinger.de](mailto:products@ettinger.de).

Subject to change and errors.