

Article datasheet

Combination Nut M4 Galvanized Steel 8.8 Toothed Lock Washer

Article-No.: 002.29.641

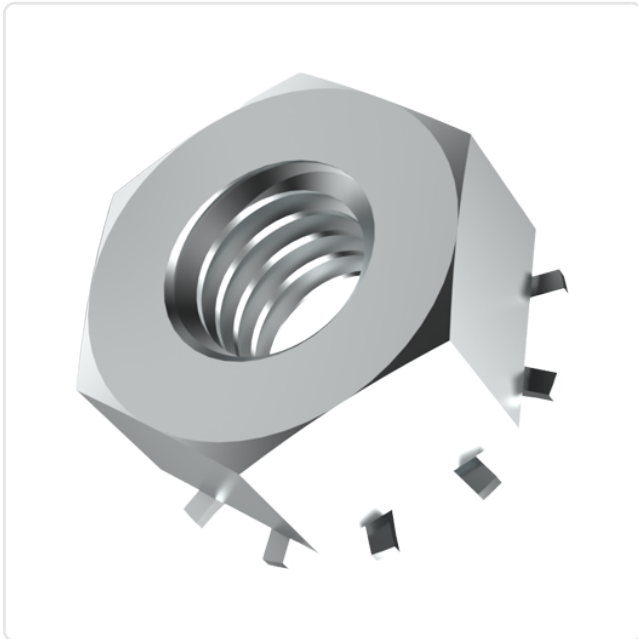
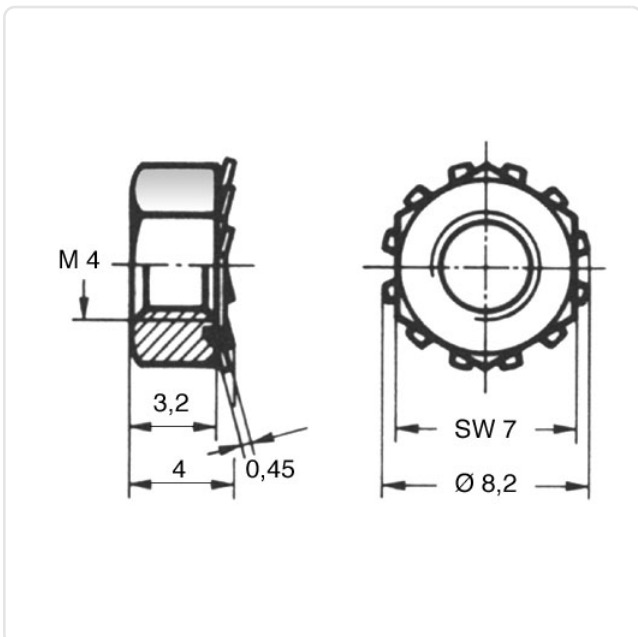

Image may be similar

AF / OD [mm]: 7
Finish: Galvanized, Blue, 5 µm, A2K
Height [mm]: 4
Material: Steel 8.8
Material Group: Steel
Thread Size: M4
Weight: 0.82g
Conformities:



You can find all
information on the web on
our article detail page



Would you like individual advice?

We look forward to your email to products@ettinger.de.

Subject to change and errors.